



# STP5NK80Z STP5NK80ZFP

N-channel 800V - 1.9Ω - 4.3A - TO-220/TO-220FP  
Zener-protected SuperMESH™ Power MOSFET

## General features

Type	V <sub>DSS</sub> (@T <sub>jmax</sub> )	R <sub>DS(on)</sub>	I <sub>D</sub>
STP5NK80Z	800 V	< 2.4 Ω	4.3 A
STP5NK80ZFP	800 V	< 2.4 Ω	4.3 A

- 100% avalanche tested
- Gate charge minimized
- Very low intrinsic capacitances
- Very good manufacturing repeatability

## Description

The SuperMESH™ series is obtained through an extreme optimization of ST's well established strip-based PowerMESH™ layout. In addition to pushing on-resistance significantly down, special care is taken to ensure a very good dv/dt capability for the most demanding applications. Such series complements ST full range of high voltage MOSFETs including revolutionary MDmesh™ products.

## Applications

- Switching application

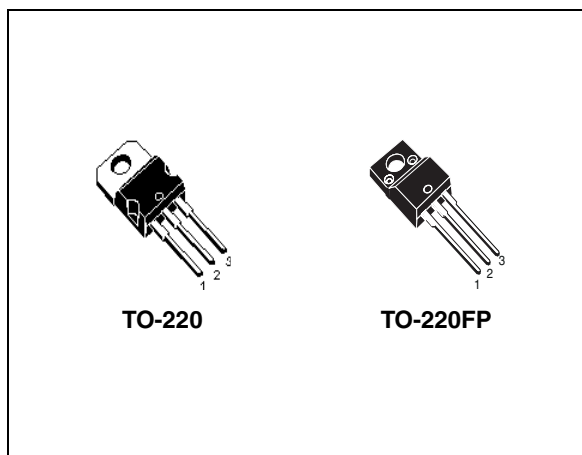

## Internal schematic diagram

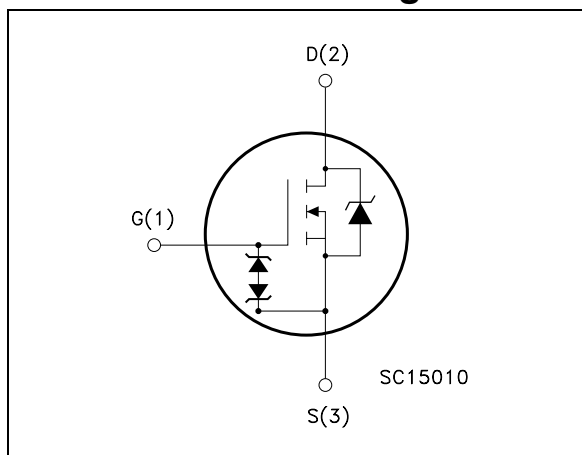

## Order codes

Part number	Marking	Package	Packaging
STP5NK80Z	P5NK80Z	TO-220	Tube
STP5NK80ZFP	P5NK80ZFP	TO-220FP	Tube

# Contents

<b>1</b>	<b>Electrical ratings</b> .....	<b>3</b>
<b>2</b>	<b>Electrical characteristics</b> .....	<b>5</b>
	2.1 Electrical characteristics (curves) .....	7
<b>3</b>	<b>Test circuit</b> .....	<b>10</b>
<b>4</b>	<b>Package mechanical data</b> .....	<b>11</b>
<b>5</b>	<b>Packaging mechanical data</b> .....	<b>12</b>

# 1 Electrical ratings

**Table 1. Absolute maximum ratings**

Symbol	Parameter	Value		Unit
		TO-220	TO-220FP	
$V_{DS}$	Drain-source voltage ( $V_{GS} = 0$ )	800		V
$V_{GS}$	Gate-source voltage	$\pm 30$		V
$I_D$	Drain current (continuous) at $T_C = 25^\circ\text{C}$	4.3	4.3 <sup>(1)</sup>	A
$I_D$	Drain current (continuous) at $T_C = 100^\circ\text{C}$	2.7	2.7 <sup>(1)</sup>	A
$I_{DM}^{(2)}$	Drain current (pulsed)	17.2	17.2 <sup>(1)</sup>	A
$P_{TOT}$	Total dissipation at $T_C = 25^\circ\text{C}$	110	30	W
	Derating factor	0.88	0.24	W/°C
$V_{ESD(G-S)}$	Gate source ESD (HBM-C=100pF, R=1.5K $\Omega$ )	3500		V
dv/dt <sup>(3)</sup>	Peak diode recovery voltage slope	4.5		V/ns
$V_{ISO}$	Insulation withstand voltage (RMS) from all three leads to external heat sink (t=1s; $T_C = 25^\circ\text{C}$ )	-	2500	V
$T_J$ $T_{stg}$	Operating junction temperature Storage temperature	-55 to 150		°C

1. Limited only by maximum temperature allowed
2. Pulse width limited by safe operating area
3.  $I_{SD} \leq 4.3\text{A}$ ,  $di/dt \leq 200\text{A}/\mu\text{s}$ ,  $V_{DD} \leq V_{(BR)DSS}$ ,  $T_J \leq T_{JMAX}$ .

**Table 2. Thermal data**

Symbol	Parameter	Value		Unit
		TO-220	TO-220FP	
$R_{thj-case}$	Thermal resistance junction-case max	1.14	4.2	°C/W
$R_{thj-a}$	Thermal resistance junction-ambient max	62.5		°C/W
$T_I$	Maximum lead temperature for soldering purpose	300		°C

**Table 3. Avalanche characteristics**

Symbol	Parameter	Value	Unit
$I_{AR}$	Avalanche current, repetitive or not-repetitive (pulse width limited by Tj Max)	4.3	A
$E_{AS}$	Single pulse avalanche energy (starting Tj=25°C, Id=Iar, Vdd=50V)	190	mJ

**Table 4. Gate-source zener diode**

Symbol	Parameter	Test conditions	Min.	Typ.	Max.	Unit
$BV_{GSO}$	Gate-source breakdown voltage	Igs=± 1mA (Open Drain)	30			V

## 1.1 Protection features of gate-to-source zener diodes

The built-in back-to-back Zener diodes have specifically been designed to enhance not only the device's ESD capability, but also to make them safely absorb possible voltage transients that may occasionally be applied from gate to source. In this respect the Zener voltage is appropriate to achieve an efficient and cost-effective intervention to protect the device's integrity. These integrated Zener diodes thus avoid the usage of external components.

## 2 Electrical characteristics

( $T_{CASE}=25^{\circ}C$  unless otherwise specified)

**Table 5. On/off states**

Symbol	Parameter	Test conditions	Min.	Typ.	Max.	Unit
$V_{(BR)DSS}$	Drain-source breakdown voltage	$I_D = 1mA, V_{GS} = 0$	800			V
$I_{DSS}$	Zero gate voltage drain current ( $V_{GS} = 0$ )	$V_{DS} = \text{Max rating},$ $V_{DS} = \text{Max rating},$ $T_c = 125^{\circ}C$			1 50	$\mu A$ $\mu A$
$I_{GSS}$	Gate body leakage current ( $V_{GS} = 0$ )	$V_{GS} = \pm 20V$			$\pm 10$	$\mu A$
$V_{GS(th)}$	Gate threshold voltage	$V_{DS} = V_{GS}, I_D = 100\mu A$	3	3.75	4.5	V
$R_{DS(on)}$	Static drain-source on resistance	$V_{GS} = 10V, I_D = 2.15 A$		1.9	2.4	$\Omega$

**Table 6. Dynamic**

Symbol	Parameter	Test conditions	Min.	Typ.	Max.	Unit
$g_{fs}^{(1)}$	Forward transconductance	$V_{DS} = 15V, I_D = 2.15A$		4.25		S
$C_{iss}$	Input capacitance	$V_{DS} = 25V, f = 1 \text{ MHz}, V_{GS} = 0$		910		pF
$C_{oss}$	Output capacitance			98		pF
$C_{rss}$	Reverse transfer capacitance			20		pF
$C_{osseq}^{(2)}$	Equivalent output capacitance	$V_{GS} = 0, V_{DS} = 0V \text{ to } 400V$		40		pF
$t_{d(on)}$	Turn-on delay time	$V_{DD} = 400V, I_D = 2A,$ $R_G = 4.7\Omega, V_{GS} = 10V$ (see <a href="#">Figure 18</a> )		18		ns
$t_r$	Rise time			25		ns
$t_{d(off)}$	Turn-off delay time			45		ns
$t_f$	Fall time			30		ns
$Q_g$	Total gate charge	$V_{DD} = 640V, I_D = 4.3A$ $V_{GS} = 10V$		32.4	45.5	nC
$Q_{gs}$	Gate-source charge			5		nC
$Q_{gd}$	Gate-drain charge			18.5		nC
$t_{d(Voff)}$	Off-voltage rise time	$V_{DD} = 640V, I_D = 4.3A,$ $R_G = 4.7\Omega, V_{GS} = 10V$ (see <a href="#">Figure 20</a> )		22		ns
$t_f$	Fall time			10		ns
$t_r$	Cross-over time			32		ns

1. Pulsed: pulse duration=300 $\mu s$ , duty cycle 1.5%

2.  $C_{osseq}$  is defined as a constant equivalent capacitance giving the same charging time as  $C_{oss}$  when  $V_{DS}$  increases from 0 to 80%  $V_{DSS}$

**Table 7. Source drain diode**

Symbol	Parameter	Test conditions	Min	Typ.	Max	Unit
$I_{SD}$	Source-drain current				4.3	A
$I_{SDM}^{(1)}$	Source-drain current (pulsed)				17.2	A
$V_{SD}^{(2)}$	Forward on voltage	$I_{SD}=4.3\text{ A}$ , $V_{GS}=0$			1.6	V
$t_{rr}$	Reverse recovery time	$I_{SD}=4.3\text{ A}$ , $di/dt = 100\text{A}/\mu\text{s}$ , $V_{DD}=40\text{ V}$ , $T_j = 150^\circ\text{C}$ (see <a href="#">Figure 20</a> )		500		ns
$Q_{rr}$	Reverse recovery charge			3		$\mu\text{C}$
$I_{RRM}$	Reverse recovery current			12		A

1. Pulse width limited by safe operating area
2. Pulsed: pulse duration=300 $\mu\text{s}$ , duty cycle 1.5%

## 2.1 Electrical characteristics (curves)

Figure 1. Safe operating area for TO-220

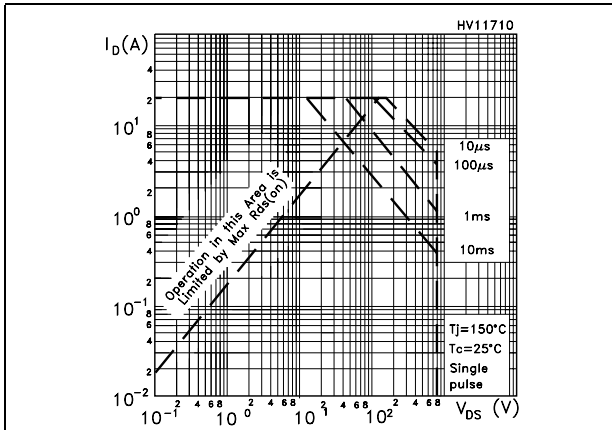

Figure 2. Thermal impedance for TO-220

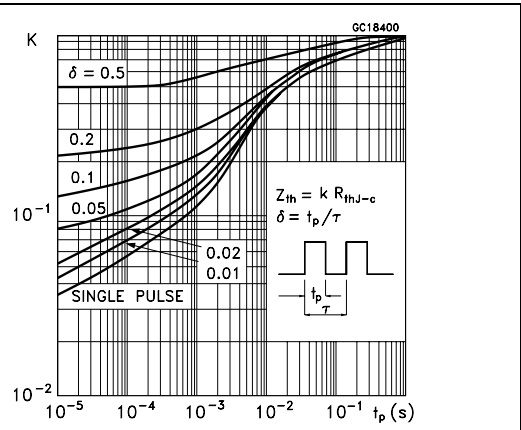

Figure 3. Safe operating area for TO-220FP (HV11720)

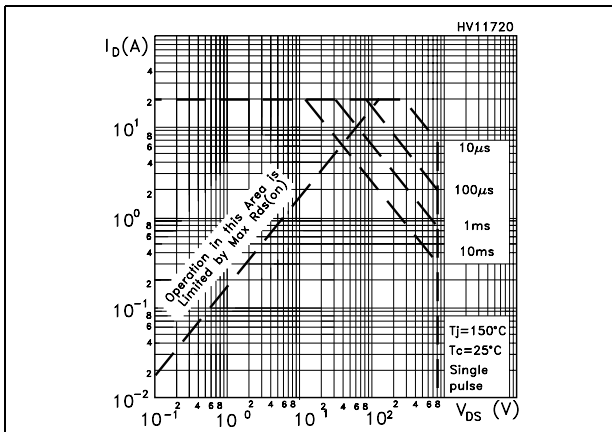

Figure 4. Thermal impedance for TO-220FP

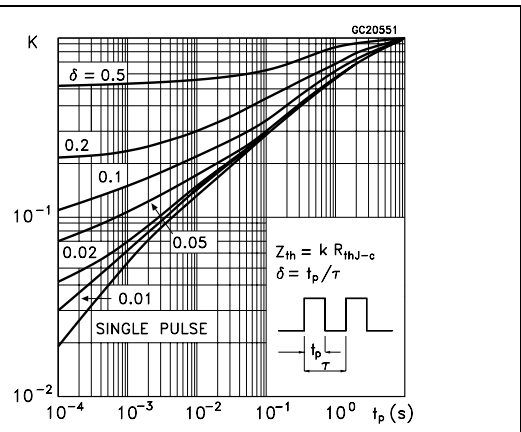

Figure 5. Output characteristics

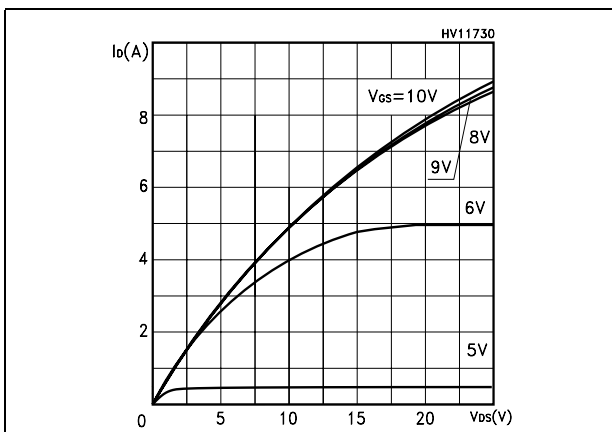

Figure 6. Transfer characteristics

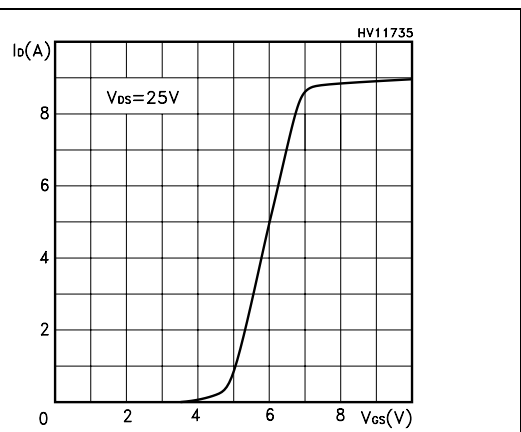

Figure 7. Transconductance

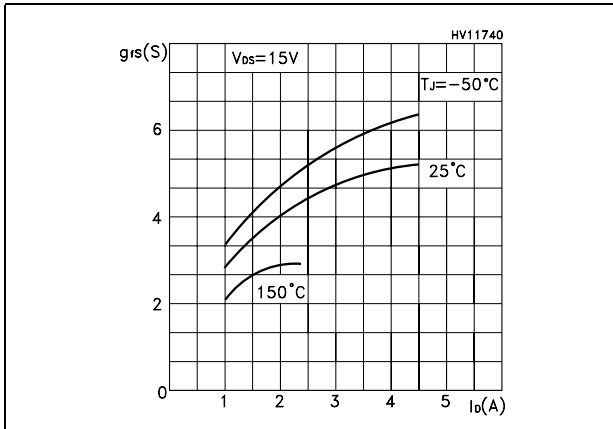

Figure 8. Static drain-source on resistance

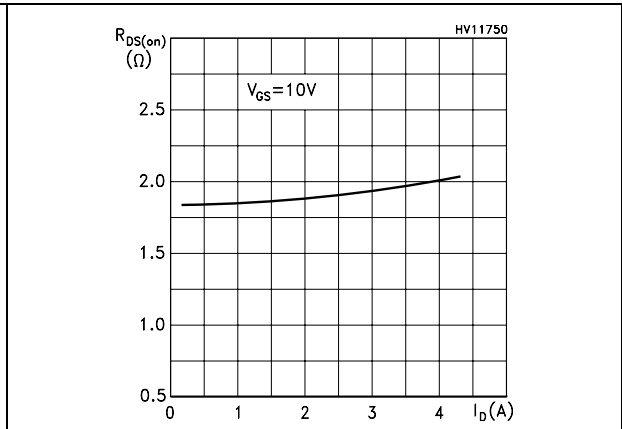

Figure 9. Gate charge vs gate-source voltage

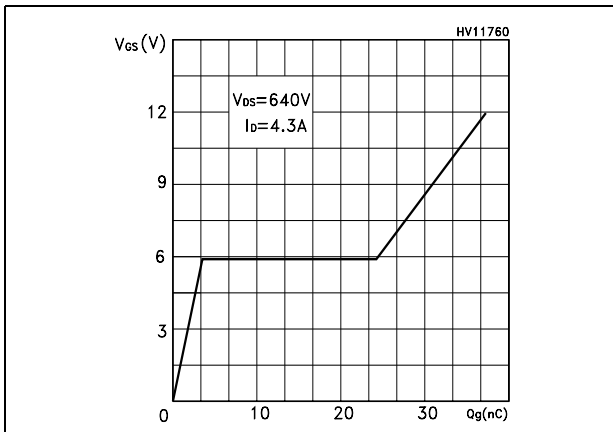

Figure 10. Capacitance variations

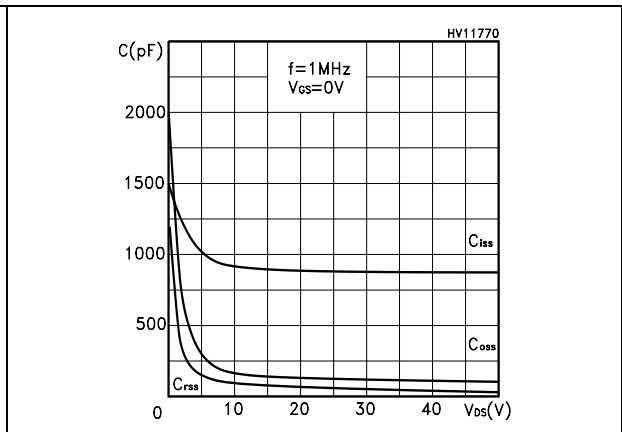

Figure 11. Normalized gate threshold voltage vs temperature

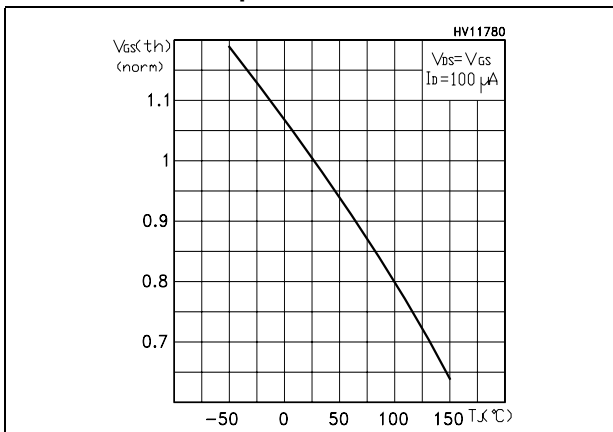

Figure 12. Normalized on resistance vs temperature

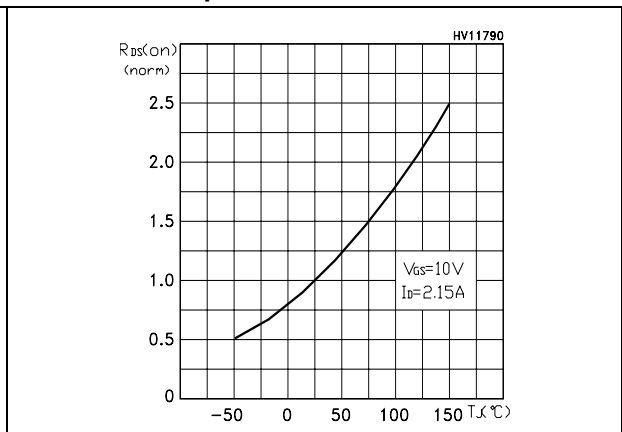



Figure 13. Source-drain diode forward characteristics

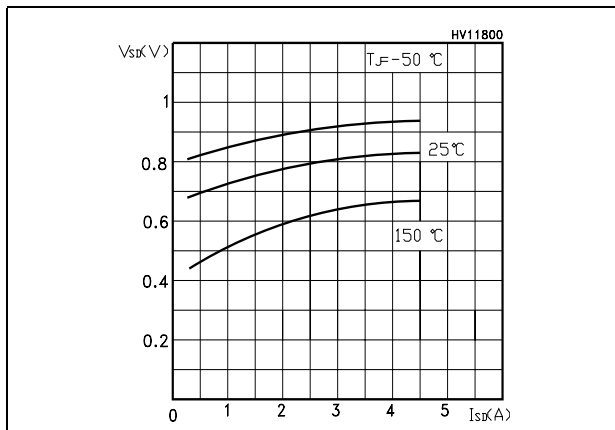

Figure 14. Normalized  $BV_{dss}$  vs temperature

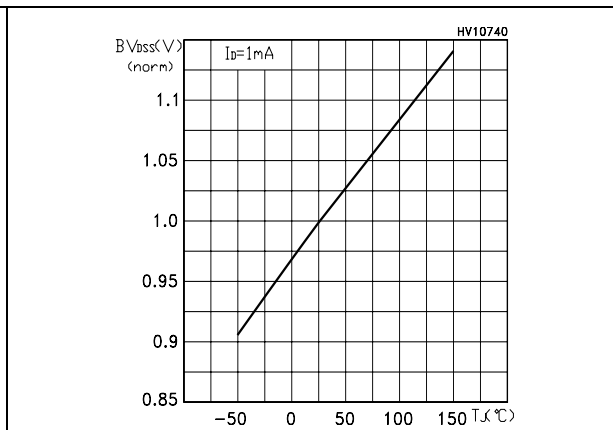
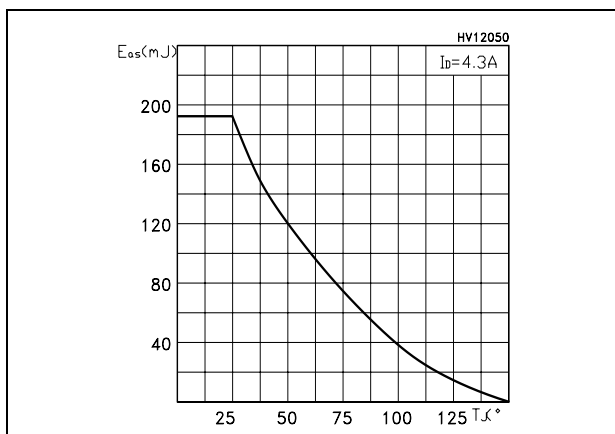

Figure 15. Avalanche energy vs temperature





## 4 Package mechanical data

In order to meet environmental requirements, ST offers these devices in ECOPACK® packages. These packages have a Lead-free second level interconnect . The category of second level interconnect is marked on the package and on the inner box label, in compliance with JEDEC Standard JESD97. The maximum ratings related to soldering conditions are also marked on the inner box label. ECOPACK is an ST trademark. ECOPACK specifications are available at: [www.st.com](http://www.st.com)

**TO-220FP MECHANICAL DATA**

DIM.	mm.			inch		
	MIN.	TYP	MAX.	MIN.	TYP.	MAX.
A	4.4		4.6	0.173		0.181
B	2.5		2.7	0.098		0.106
D	2.5		2.75	0.098		0.108
E	0.45		0.7	0.017		0.027
F	0.75		1	0.030		0.039
F1	1.15		1.7	0.045		0.067
F2	1.15		1.7	0.045		0.067
G	4.95		5.2	0.195		0.204
G1	2.4		2.7	0.094		0.106
H	10		10.4	0.393		0.409
L2		16			0.630	
L3	28.6		30.6	1.126		1.204
L4	9.8		10.6	.0385		0.417
L5	2.9		3.6	0.114		0.141
L6	15.9		16.4	0.626		0.645
L7	9		9.3	0.354		0.366
Ø	3		3.2	0.118		0.126

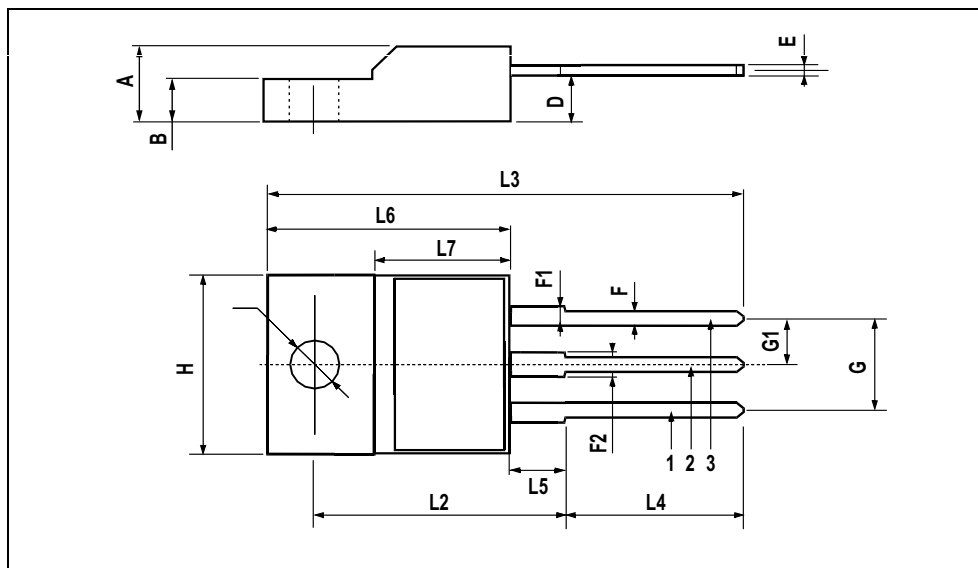

TO-220 MECHANICAL DATA						
DIM.	mm.			inch		
	MIN.	TYP.	MAX.	MIN.	TYP.	MAX.
A	4.40		4.60	0.173		0.181
b	0.61		0.88	0.024		0.034
b1	1.15		1.70	0.045		0.066
c	0.49		0.70	0.019		0.027
D	15.25		15.75	0.60		0.620
E	10		10.40	0.393		0.409
e	2.40		2.70	0.094		0.106
e1	4.95		5.15	0.194		0.202
F	1.23		1.32	0.048		0.052
H1	6.20		6.60	0.244		0.256
J1	2.40		2.72	0.094		0.107
L	13		14	0.511		0.551
L1	3.50		3.93	0.137		0.154
L20		16.40			0.645	
L30		28.90			1.137	
øP	3.75		3.85	0.147		0.151
Q	2.65		2.95	0.104		0.116

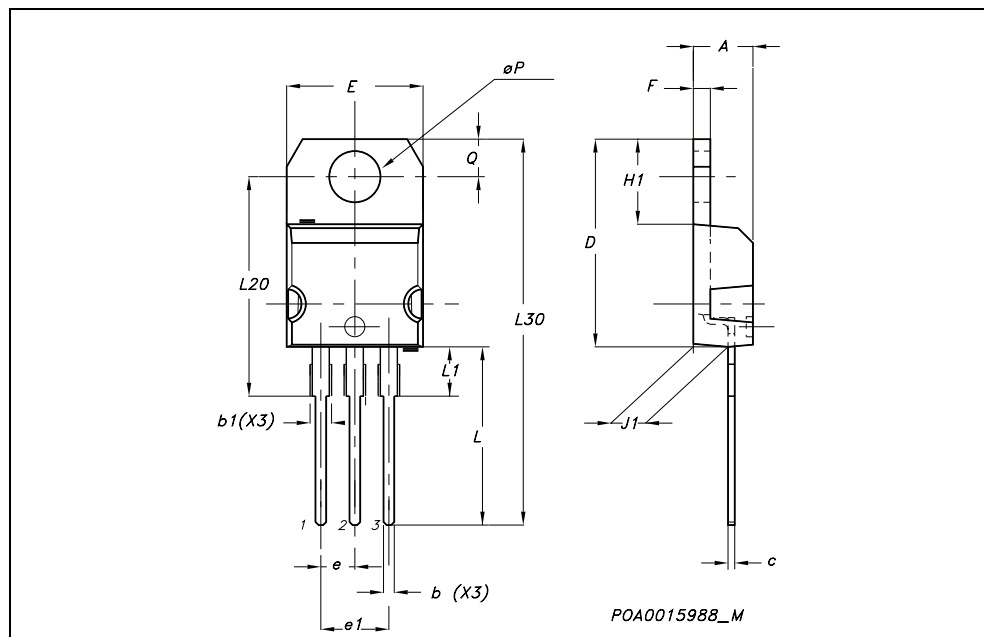

## 5 Revision history

**Table 8. Revision history**

<b>Date</b>	<b>Revision</b>	<b>Changes</b>
09-Sep-2004	2	Preliminary version
06-Sep-2005	3	Final version
16-Aug-2006	4	New template, no content change

**Please Read Carefully:**

Information in this document is provided solely in connection with ST products. STMicroelectronics NV and its subsidiaries ("ST") reserve the right to make changes, corrections, modifications or improvements, to this document, and the products and services described herein at any time, without notice.

All ST products are sold pursuant to ST's terms and conditions of sale.

Purchasers are solely responsible for the choice, selection and use of the ST products and services described herein, and ST assumes no liability whatsoever relating to the choice, selection or use of the ST products and services described herein.

No license, express or implied, by estoppel or otherwise, to any intellectual property rights is granted under this document. If any part of this document refers to any third party products or services it shall not be deemed a license grant by ST for the use of such third party products or services, or any intellectual property contained therein or considered as a warranty covering the use in any manner whatsoever of such third party products or services or any intellectual property contained therein.

**UNLESS OTHERWISE SET FORTH IN ST'S TERMS AND CONDITIONS OF SALE ST DISCLAIMS ANY EXPRESS OR IMPLIED WARRANTY WITH RESPECT TO THE USE AND/OR SALE OF ST PRODUCTS INCLUDING WITHOUT LIMITATION IMPLIED WARRANTIES OF MERCHANTABILITY, FITNESS FOR A PARTICULAR PURPOSE (AND THEIR EQUIVALENTS UNDER THE LAWS OF ANY JURISDICTION), OR INFRINGEMENT OF ANY PATENT, COPYRIGHT OR OTHER INTELLECTUAL PROPERTY RIGHT.**

**UNLESS EXPRESSLY APPROVED IN WRITING BY AN AUTHORIZED ST REPRESENTATIVE, ST PRODUCTS ARE NOT RECOMMENDED, AUTHORIZED OR WARRANTED FOR USE IN MILITARY, AIR CRAFT, SPACE, LIFE SAVING, OR LIFE SUSTAINING APPLICATIONS, NOR IN PRODUCTS OR SYSTEMS WHERE FAILURE OR MALFUNCTION MAY RESULT IN PERSONAL INJURY, DEATH, OR SEVERE PROPERTY OR ENVIRONMENTAL DAMAGE. ST PRODUCTS WHICH ARE NOT SPECIFIED AS "AUTOMOTIVE GRADE" MAY ONLY BE USED IN AUTOMOTIVE APPLICATIONS AT USER'S OWN RISK.**

Resale of ST products with provisions different from the statements and/or technical features set forth in this document shall immediately void any warranty granted by ST for the ST product or service described herein and shall not create or extend in any manner whatsoever, any liability of ST.

ST and the ST logo are trademarks or registered trademarks of ST in various countries.

Information in this document supersedes and replaces all information previously supplied.

The ST logo is a registered trademark of STMicroelectronics. All other names are the property of their respective owners.

© 2006 STMicroelectronics - All rights reserved

STMicroelectronics group of companies

Australia - Belgium - Brazil - Canada - China - Czech Republic - Finland - France - Germany - Hong Kong - India - Israel - Italy - Japan - Malaysia - Malta - Morocco - Singapore - Spain - Sweden - Switzerland - United Kingdom - United States of America

[www.st.com](http://www.st.com)

# Mouser Electronics

Authorized Distributor

Click to View Pricing, Inventory, Delivery & Lifecycle Information:

[STMicroelectronics:](#)

[STP5NK80Z](#) [STP5NK80ZFP](#)